

3

4

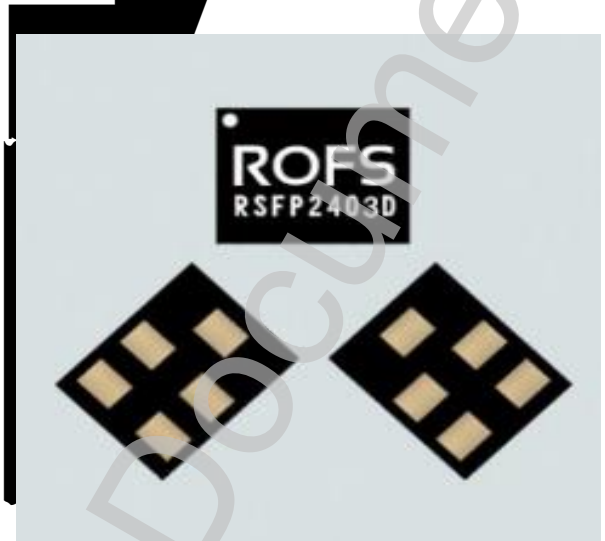

1 3

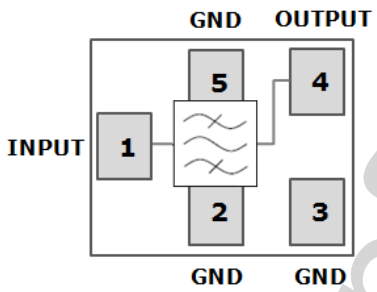

0

ISM band applications such as Smart Meters  
Portable Hotspots and Mobile Routers

4

2







ROFES  
SYSTEM

3

4

, 2

S22

S11

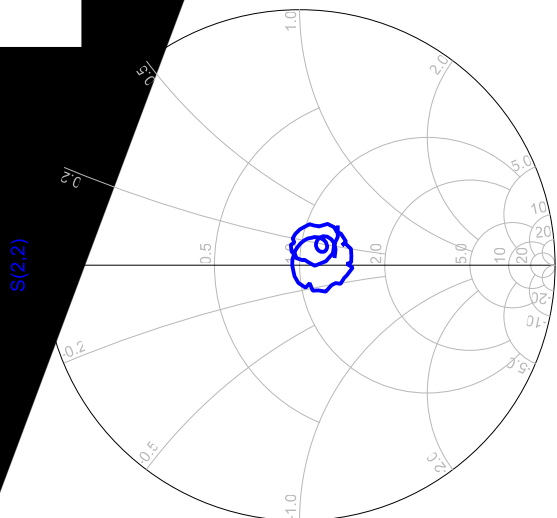
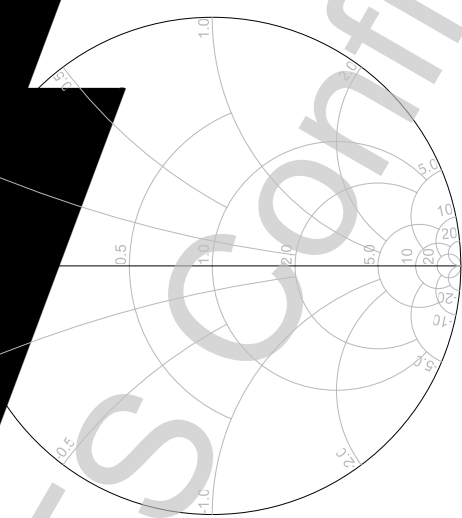
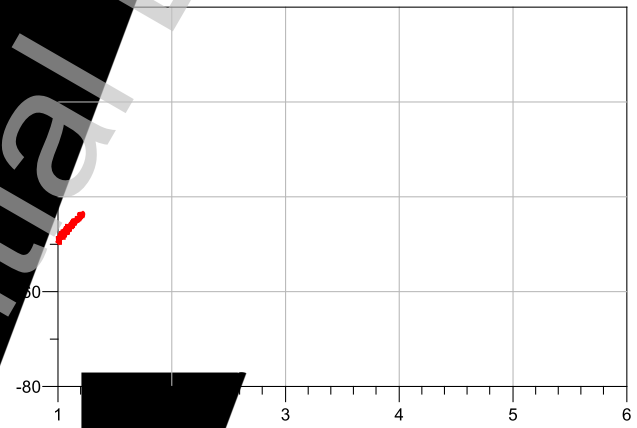
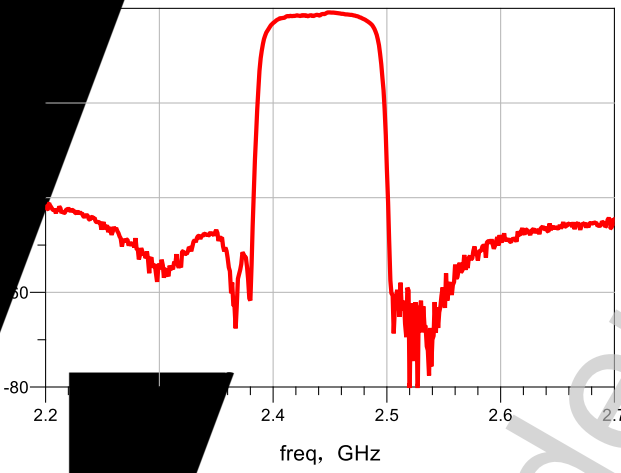

freq (2.402GHz to 2.482GHz)

2

2

/ 3 0 0

3

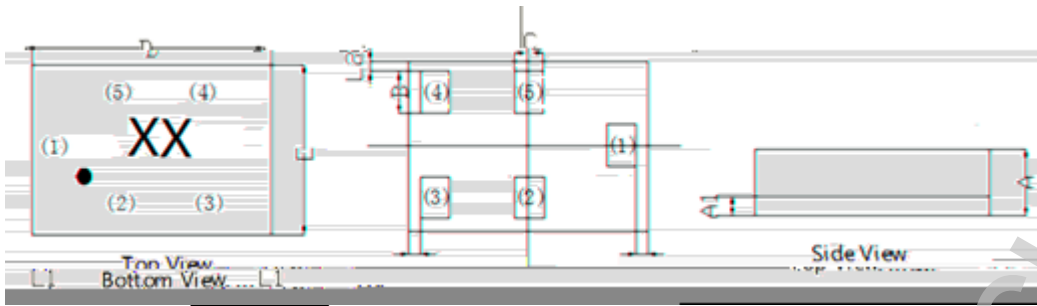

Symbol	DIMENSION REQUIREMENT		
	MIN	NOM	MAX
A	0.56	0.61	0.66
A1	0.16	0.21	0.26
B	0.275	0.325	0.375
C	0.20	0.25	0.30
D	1.35	1.4	1.45
E	1.05	1.1	1.15
L1	0.05	0.1	0.15
L2	0.025	0.075	0.125

2

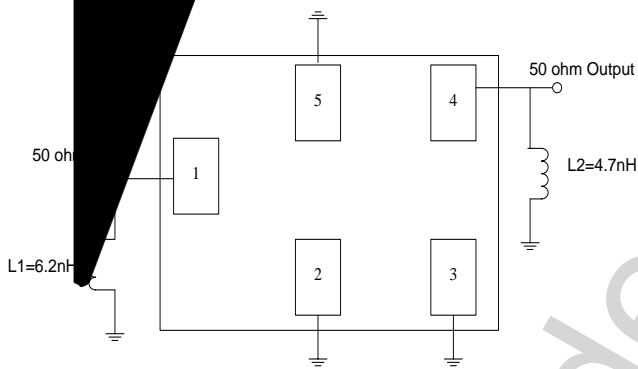

21

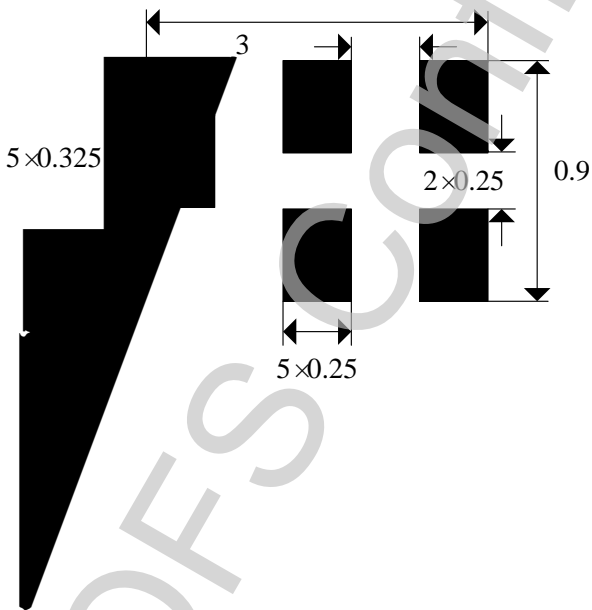

3

3

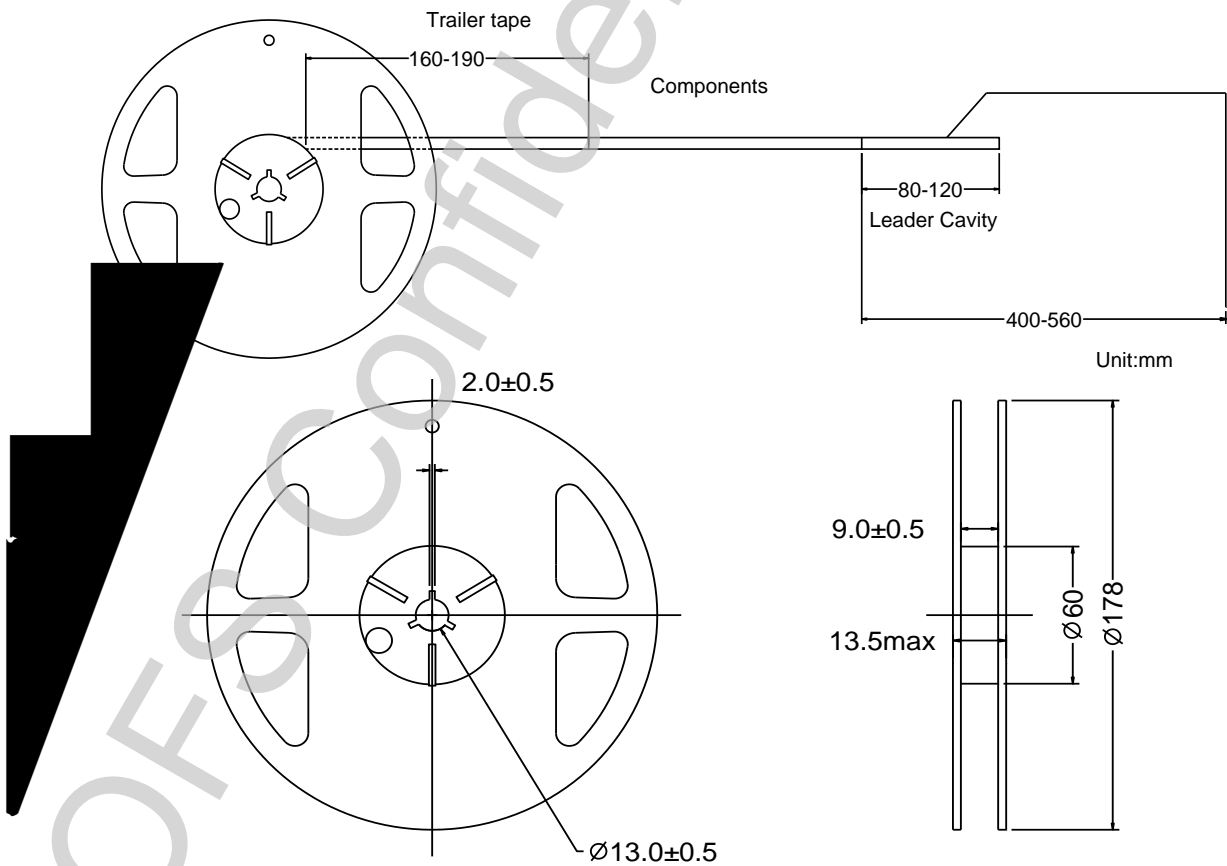

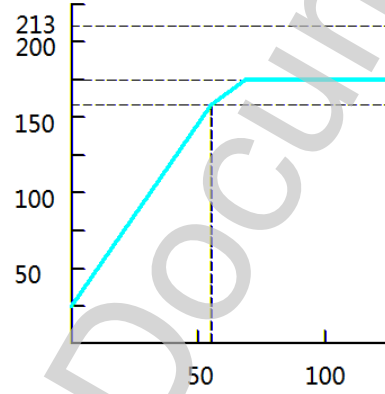
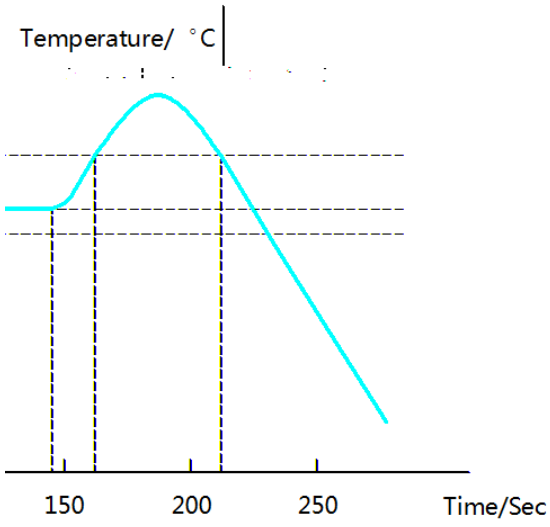

---



---



---